

LGR032 x=318
LGR042 x=456

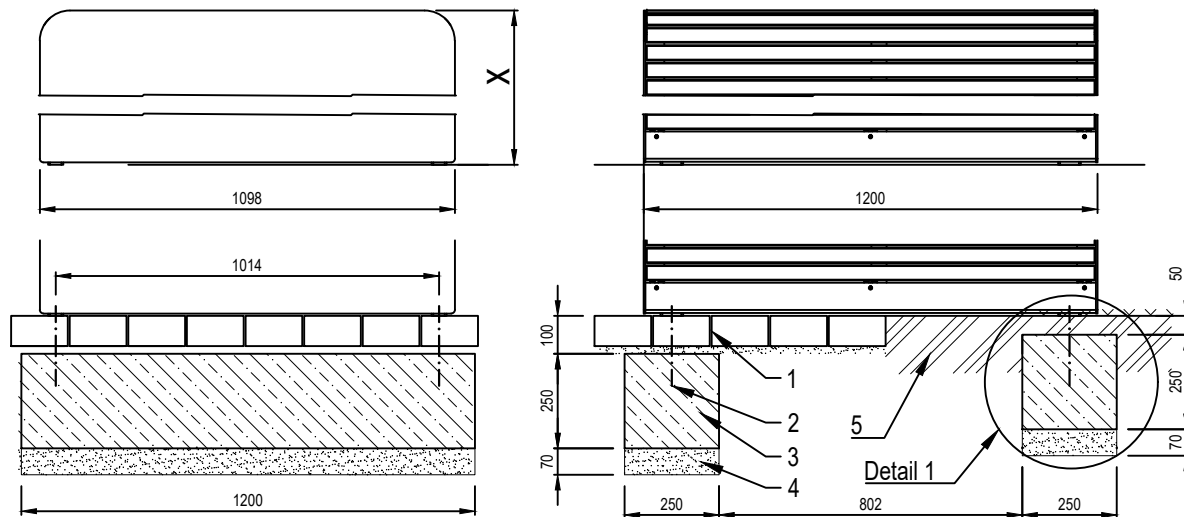

0.15 m3
beton C 20/25
concrete C 20/25

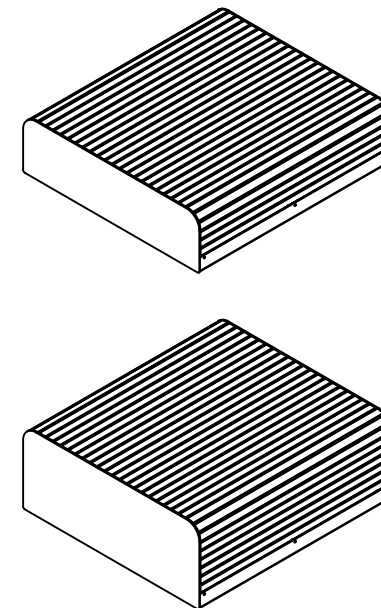
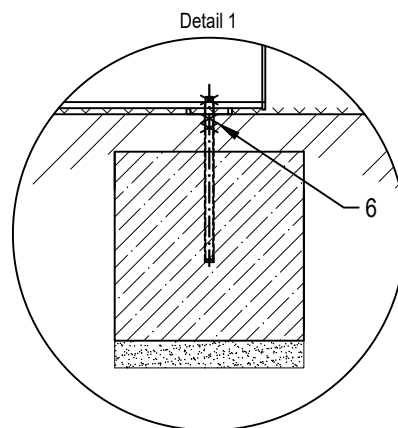

LEGENDA:

- 1 Dlažba
- 2 Chemická kotva M10, dl. min 200
- 3 Betonový základ
- 4 Štěrkové lože ztuhněné, tl. min. 70 mm
- 5 Zeminový podklad
- 6 Kontramatice (pro zeminový podklad)

LEGEND:

- 1 Pavement
- 2 Chemical anchor M10, dl. min 200
- 3 Concrete foundation
- 4 Compacted gravel base, depth min. 70 mm
- 5 Soil foundation
- 6 Counter nuts (for soil foundation)