

- Instrucciones de anclaje
- Instructions pour le scellement
- Anchoring instructions

4 x DIN7991 M8 x 25
4 x DIN6334 M8 x 24
4 x DIN975 M8 x 200

No incluido
Non inclus
Not included

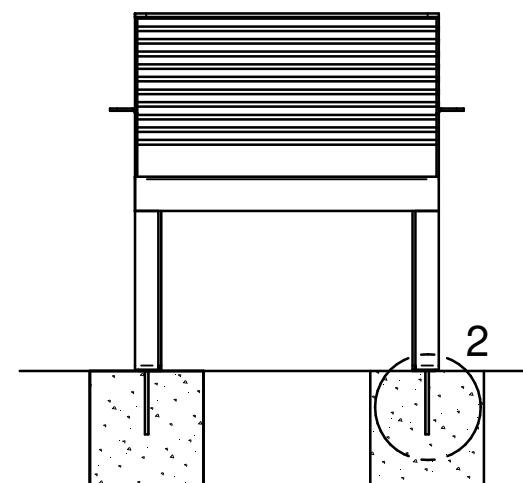
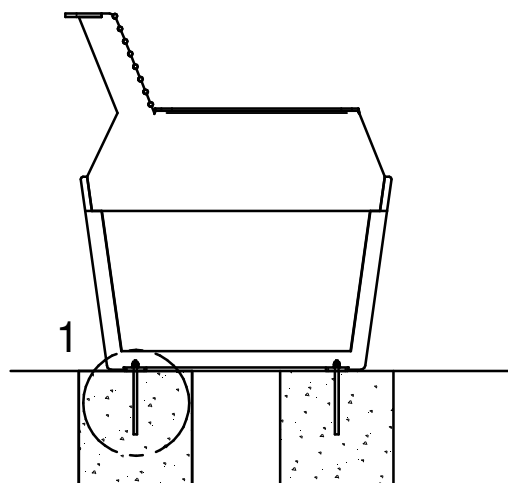
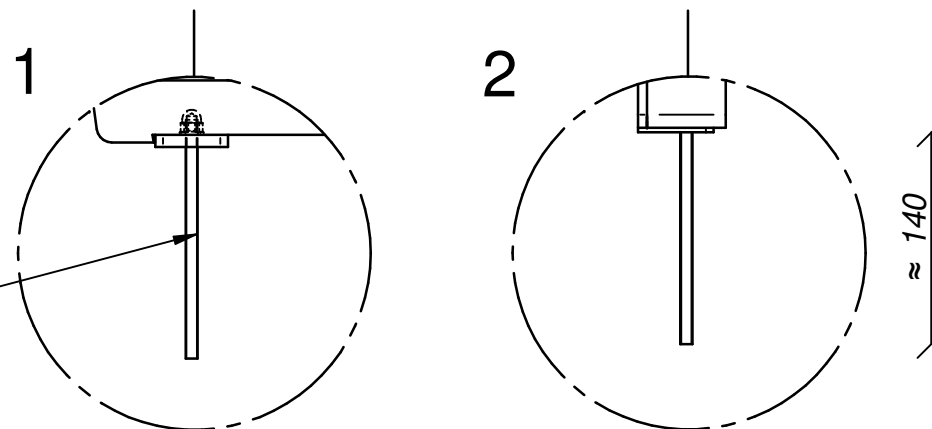

 Hormigón
Béton
Concrete

≈ 440

≈ 620



Información importante
Information important
Important information



Verificar el buen estado del material, sin golpes ni rozaduras en el embalaje.
Vérifier le bon état du matériel. sans coups ni rayures sur l'emballage.
Verify the good condition of the material, without knocks or scratches on the packaging.



Se debe descargar el material con sumo cuidado. Se recomienda la descarga entre dos personas.
Le matériel doit être déchargé avec un soin extrême. Il est recommandé d'e télécharger entre deux personnes.
The material must be unloaded with extreme care. It is recommended to download between two people.



No golpear ni arrastrar el material.
Ne frappez pas et ne faites pas glisser le matériau.
Do not hit or drag the material.

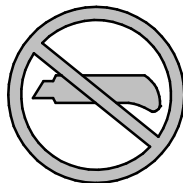

Desembalar el material con cuidado. Es obligatorio retirar el embalaje con la mayor brevedad posible.
Déballer soigneusement le matériel en retirant l'emballage le plus tôt possible.
Unpack the material carefully. It is mandatory to remove the packaging as soon as possible.



Realizar la instalación con cuidado y por personal cualificado, utilizar las herramientas adecuadas.
Effectuez l'installation avec soin, et par du personnel qualifié, utiliser les outils appropriés.
Carry out the installation with care and by qualified personnel, use the appropriate tools.



Retirar y limpiar la suciedad y restos de la instalación.
Effectuez l'installation avec soin, et par du personnel qualifié, utiliser les outils appropriés.
Carry out the installation with care and by qualified personnel, use the appropriate tools.

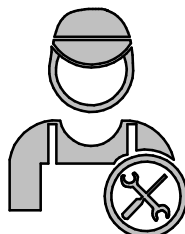

Es necesario realizar un mantenimiento preventivo periódicamente. (ver hojas de mantenimiento.)
Il est nécessaire d'effectuer une maintenance préventive périodique (voir fiches de maintenance).
It is necessary to perform preventive maintenance periodically (see maintenance sheets).